









Mounting guide



Ava Compact Dome

Avigilon Alta Cloud Security

Important Warnings and Safety Instructions

-  **Avoid** exposing the device to shocks, high pressure or temperatures above 45°C.
-  **Avoid** placing the device near fans, ventilation or other noise sources. This will degrade audio performance.
-  **Avoid** scratching or leaving fingerprints on the lens cover, this degrades image quality. If possible, keep the protective plastic on the lens cover during installation.
-  **Do not** clean the camera with harsh detergents, gasoline or chemicals such as acetone.
-  **Do not** try to repair the unit yourself. Refer all servicing of the camera to Avigilon or contact a reseller.
-  **Do not** install the camera in conditions of high humidity. Water may be trapped inside, causing damage or condensation issues.
-  This product should be supplied by a Power over Ethernet (PoE) Power Sourcing Equipment (PSE) compliant to IEEE 802.3af. The PSE should be UL listed and marked "Limited Power Source" or "LPS". The output should be rated 48V and 12W minimum from the connected port.
-  The camera and the PoE PSE must be installed within the same building, as described by Environment A of the IEEE 802.3af standard. The PoE PSE must be properly grounded.



Box contents

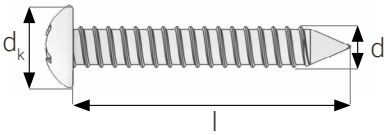
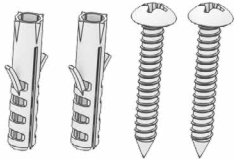
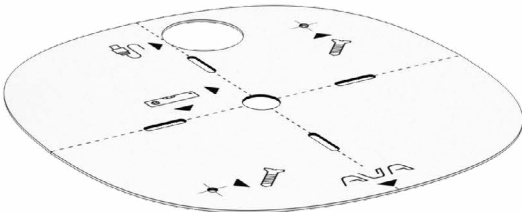

Screw dimensions

$d_k = 9.2 \text{ mm}$
 $l = 32 \text{ mm}$

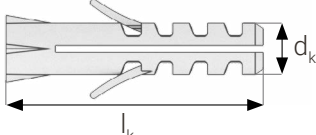

Anchor dimensions

$l_k = 30 \text{ mm}$
 $d_k = 6 \text{ mm}$



Camera placement

High on a wall or in the ceiling are good placements for the camera.

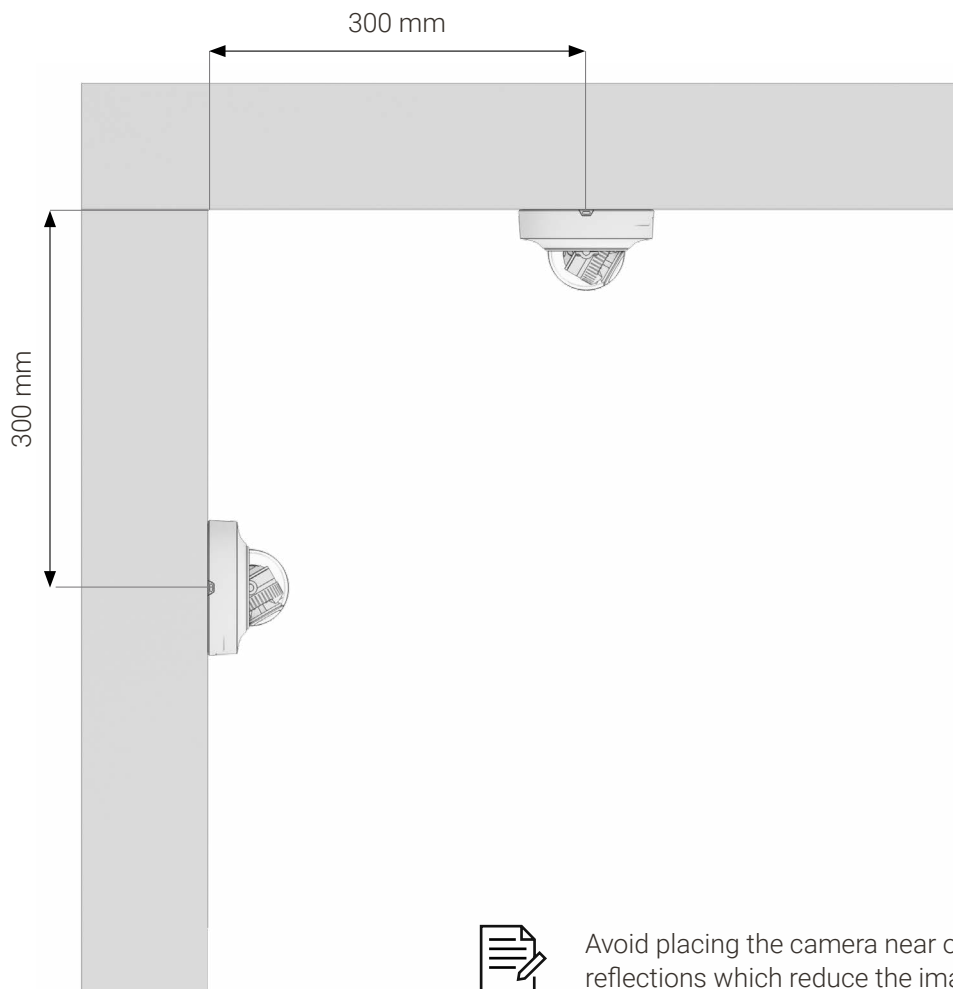

Avoid placing the camera near obstacles and overhangs, or in a corner. This causes reflections which reduce the image quality, especially when using night vision.

Using the drilling template to place the camera

1

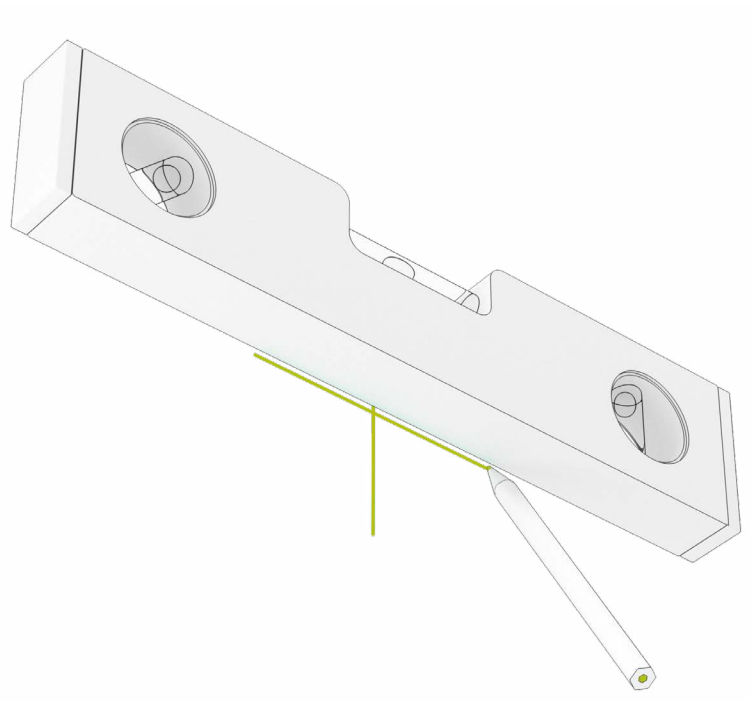

2

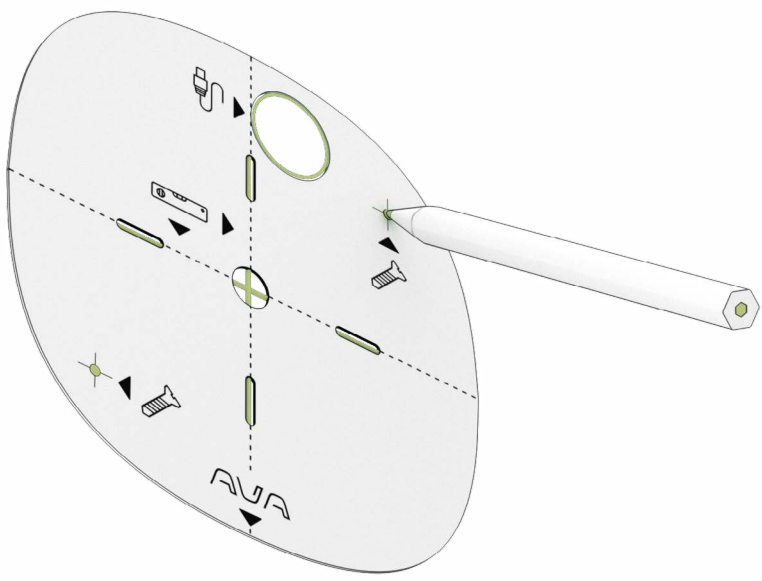

 For through the wall cable connections, mark the cable entry position using the template.

Drill the holes and install the anchors and camera

3

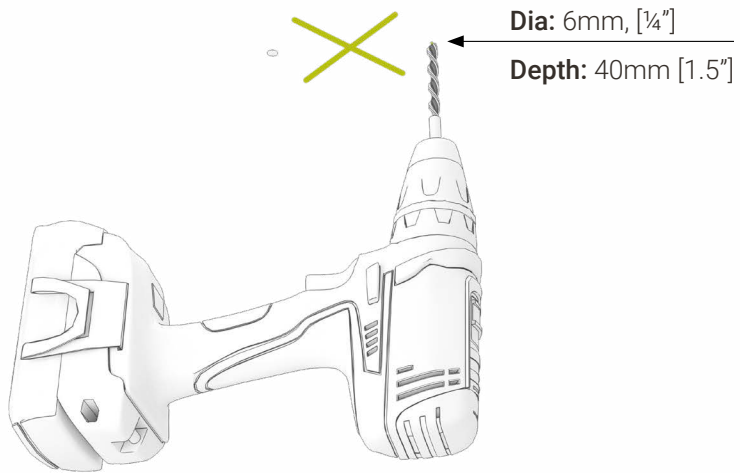

4



5

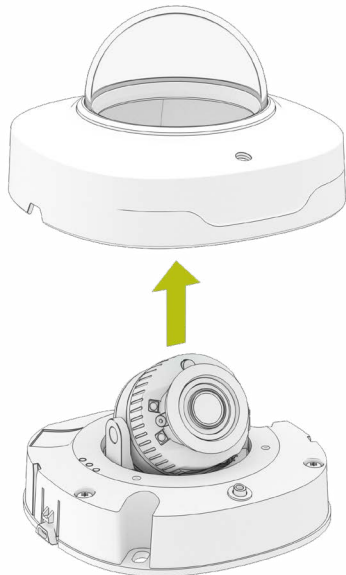

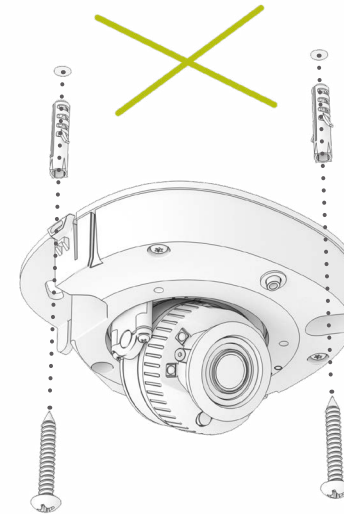

6

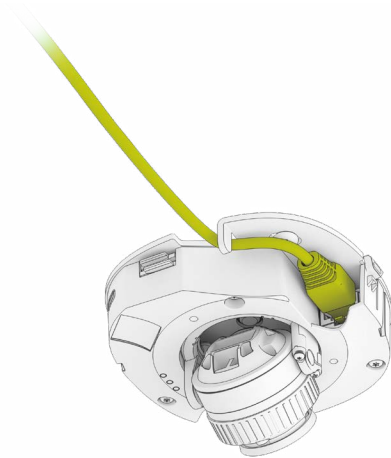

Attach the ethernet cable

7



 Make sure the light sensor is not covered by the casing.

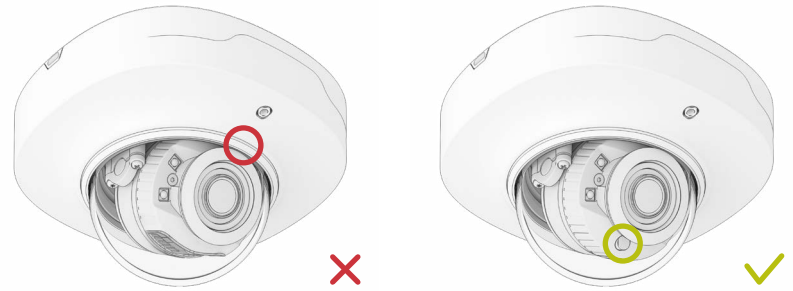

Adjust the picture

Use the video stream to confirm the image orientation.

8

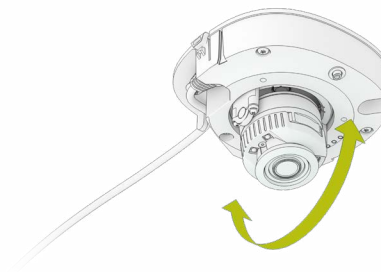
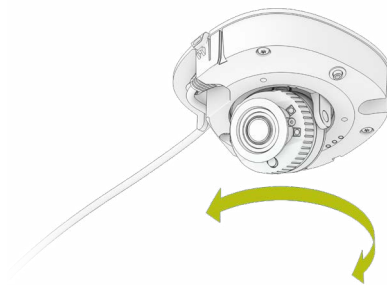
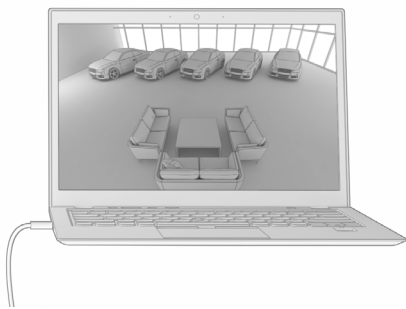

 Adjust the image orientation in Alta Video.



Install the top cover

9

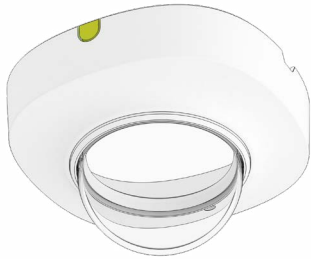

For side entry cable connections, you must remove the the cable bridging piece.

10

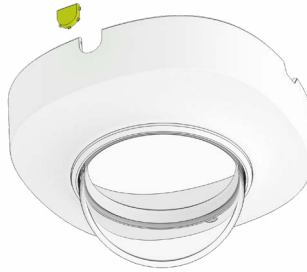

Use a long nose pliers or similar to pull out the cable bridging piece.

11



12



13



To learn more, visit:
www.avigilon.com



AVIGILON™

Motorola Solutions, Inc. 500 West Monroe Street, Chicago, IL 60661 U.S.A. motorolasolutions.com

MOTOROLA, MOTO, MOTOROLA SOLUTIONS and the Stylized M Logo are trademarks or registered trademarks of Motorola Trademark Holdings, LLC and are used under license. All other trademarks are the property of their respective owners. ©2024 Motorola Solutions, Inc. All rights reserved. 11-2024 [DS02]